



Tubular Heaters

Screw Plug



UL and C-UL Recognized-E177353

Features

- Ratings and sizes other than those listed above are available.
- Brass, steel, or stainless steel screw plugs in 1", 1¼", 2", and 2½" sizes.
- Element supports in multiple element units for proper element spacing as required.
- Steel, stainless steel, copper, or incoloy sheathed elements. One, two or three per unit depending on size.
- Optional thermostat and well for temperature control.
- General purpose terminal housing with conduit opening. Optional terminal housings for special applications.
- 120V, 208V, 240V, 480V, single or three phase which are factory wired to your requirements.
- Long, trouble free service.
- Made in U.S.A.

Construction

- 1 Terminal housing, NEMA 1 general purpose for electrical connections.
- 2 Screw plug.
- 3 Tubular heating element.

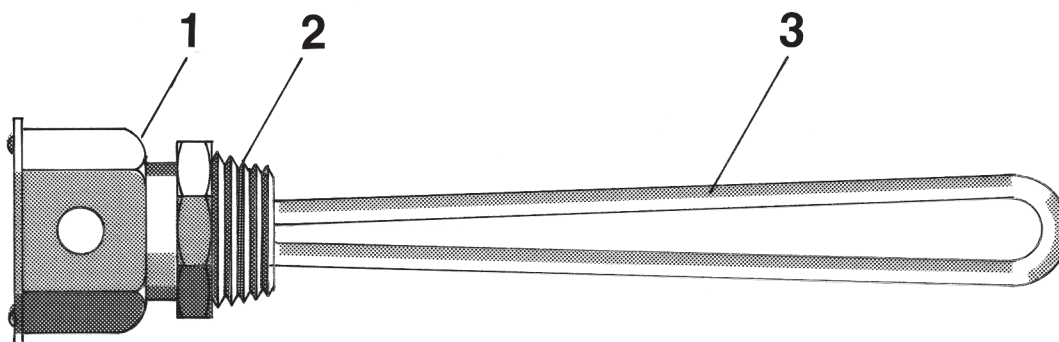

TUBULAR



Tubular Heaters

Screw Plug

Screw Plug Heater Selection Guide

Application	Solution or Application	Alkaline or Acid Content (Est. % by Volume)	Sheath Material	Typical Watt Density (watts/sq. in.)	Screw Plug Material
Water and Very Mild Solutions	Clean Water	pH6 to pH8 Neutral	Copper	45	Brass
	Process Water or Very Mild Solutions	pH5 to pH9 2-3%	Incoloy	45	Stainless Steel
	Mild Solutions	5-6%	Incoloy	45	Stainless Steel
	Demineralized or Deionized Water	—	Incoloy	45	Stainless Steel Stainless Steel
Oil Heating*	Low Viscosity Oil	—	Steel	23	Steel
	Medium Viscosity Oil	—	Steel	15	Steel
	High Viscosity Oil	—	Steel	6	Steel
Specialty Heaters	Process Water	pH5-pH9	Incoloy	45	Brass
	Demineralized Water	—	Incoloy	45	Stainless Steel
	Low Viscosity Oil	—	Incoloy	23	Steel
	Pipe Insert	—	Incoloy	12	Steel
	Hot Tubs, Spa	Treated	Incoloy	100	Brass
Commercial Equipment	Clean Water	—	Incoloy	30	Brass
	Clean Water	—	Copper	60	Brass

*The oil heaters on following pages are catalogued based on low viscosity oil. For medium and high viscosity oils, watt densities must be reduced in accordance with the above watt densities.

Installation

The heater is screwed into a pipe coupling or half coupling in the tank. Units must be immersed at all times for proper operation.

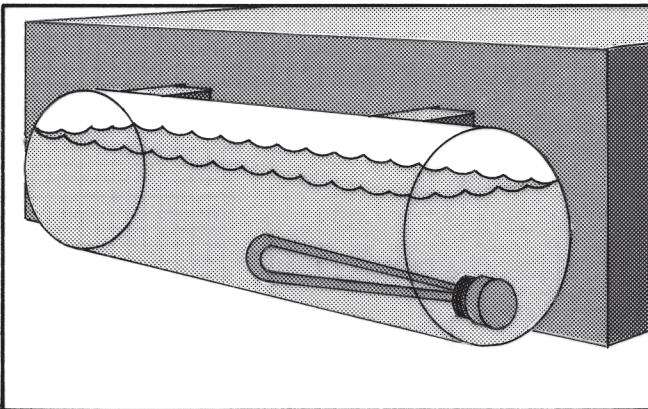

Oil Reservoir Heater

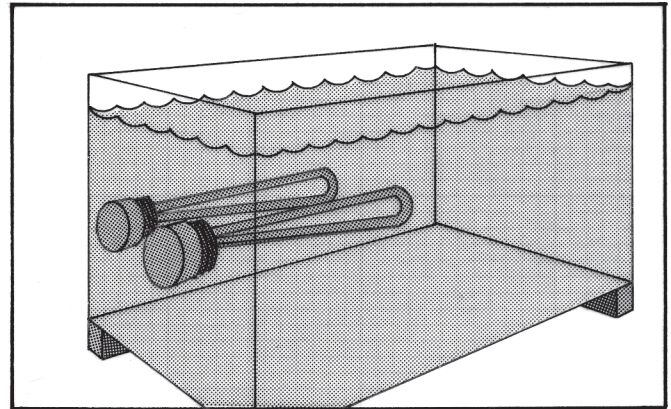

Tank Heater

TUBULAR



Tubular Heaters

Screw Plug

Copper Sheath

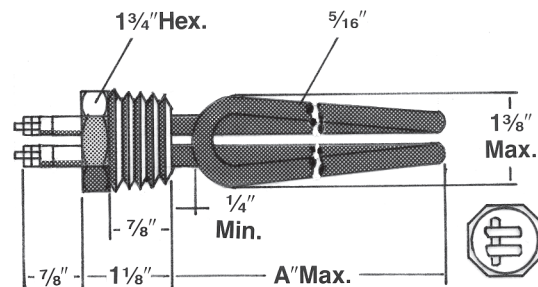
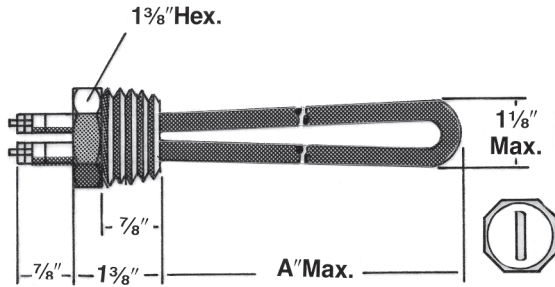

1" NPT: Copper Sheath

No. of Elements: 1

Plug Type: Brass Screw

Watts/sq. in.: Approx. 80

Application: Water

A Dim.	Imm. Lgth	Cat. No.	Kilo-watts	Volts
5 1/4"		LC9-5.25-X	.35	120
6 3/8"		LC9-6.37-X	.50	120
6 3/8"		LC9-6.37-X	.60	120
6 3/8"		LC9-6.37-X	.75	120
6 3/8"		LC9-6.37-X	.75	240
6 3/8"		LC9-6.37-X	1.0	120
6 3/8"		LC9-6.37-X	1.0	240
8 1/8"		LC9-8.12-X	1.2	120
8 1/8"		LC9-8.12-X	1.2	240
9 1/4"		LC9-9.25-X	1.5	120
9 1/4"		LC9-9.25-X	1.5	240
12 1/4"		LC9-12.25-X	2.0	120

1 1/4" NPT: Copper Sheath

No. of Elements: 1 (Fold Back Design)

Plug Type: Brass

Watts/sq. in.: Approx. 80

Application: Water

A Dim.	Imm. Lgth	Cat. No.	Kilo-watts	Volts
6 1/8"		LC11-6.12-X	1.0	120
6 1/8"		LC11-6.12-X	1.0	240
6 5/8"		LC11-6.62-X	2.0	120
6 5/8"		LC11-6.62-X	2.0	240
8 1/2"		LC11-8.5-X	2.5	120
9 1/8"		LC11-9.06-X	1.5	120
9 1/8"		LC11-9.06-X	1.5	240
10 3/8"		LC11-10.18-X	3.0	240
13 3/8"		LC11-13.56-X	4.0	240
16 1/8"		LC11-16.93-X	5.0	240

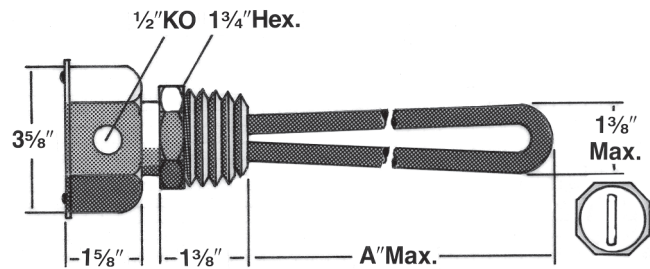

1 1/4" NPT: Copper Sheath

No. of Elements: 1

Plug Type: Brass

Watts/sq. in.: Approx. 45min. - 80max.

Application: Water

Terminal Enclosure: NEMA 1

A Dim.	Imm. Lgth	Cat. No.	Kilo-watts	Volts
6 1/8"		LC9-6.12-XJ	.60	120
6 1/8"		LC9-6.12-XJ	.60	240
6 1/8"		LC9-6.12-XJ	.75	120
6 1/8"		LC9-6.12-XJ	.75	240
6 1/8"		LC9-6.12-XJ	1.0	120
6 1/8"		LC9-6.12-XJ	1.0	240

TUBULAR



Tubular Heaters

Screw Plug

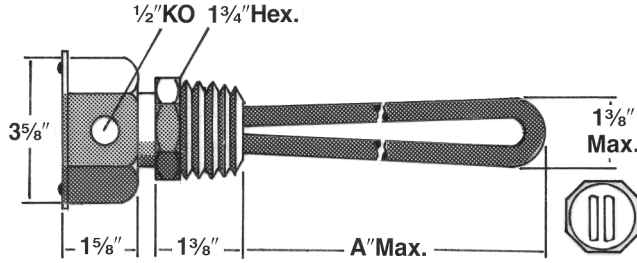

1 1/4" NPT: Copper Sheath

No. of Elements: 2			
Plug Type: Brass			
Watts/sq. in.: Approx. 45min. – 80max.			
Application: Water			
Terminal Enclosure: NEMA 1			

A Dim. Imm. Lgth	Cat. No.	Kilo-watts	Volts
6 1/2"	LC11-6.12-YJ	1.0	120
6 1/2"	LC11-6.12-YJ	1.0	240
6 1/2"	LC11-6.12-YJ	1.2	120
6 1/2"	LC11-6.12-YJ	1.2	240
6 1/2"	LC11-6.12-YJ	1.5	120
6 1/2"	LC11-6.12-YJ	1.5	240
6 1/2"	LC11-6.12-YJ	2.0	120
6 1/2"	LC11-6.12-YJ	2.0	240

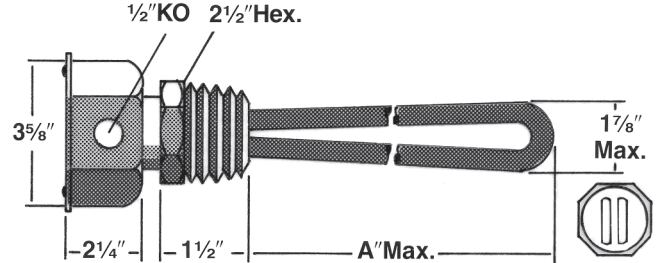

2" NPT: Copper Sheath

No. of Elements: 2			
Plug Type: Brass Screw			
Watts/sq. in.: Approx. 45			
Application: Water			
Terminal Enclosure: NEMA 1			

A Dim. Imm. Lgth	Cat. No.	Kilo-watts	Volts
7 1/2"	LC13-7.87-YJ	2.0	120
7 1/2"	LC13-7.87-YJ	2.0	240
7 1/2"	LC13-7.87-YJ	2.0	480
9 3/8"	LC13-9.37-YJ	2.5	120
9 3/8"	LC13-9.37-YJ	2.5	240
9 3/8"	LC13-9.37-YJ	2.5	480
12"	LC13-12-YJ	3.0	120
12"	LC13-12-YJ	3.0	240
12"	LC13-12-YJ	3.0	480
18"	LC13-18-YJ	4.0	240
18"	LC13-18-YJ	4.0	480
19 7/8"	LC13-19.87-YJ	5.0	240
19 7/8"	LC13-19.87-YJ	5.0	480
25"	LC13-25-YJ	6.0	240
25"	LC13-25-YJ	6.0	480
28"	LC13-28-YJ	7.0	240
28"	LC13-28-YJ	7.0	480
40 3/4"	LC13-40.37-YJ	10.0	240
40 3/4"	LC13-40.37-YJ	10.0	480

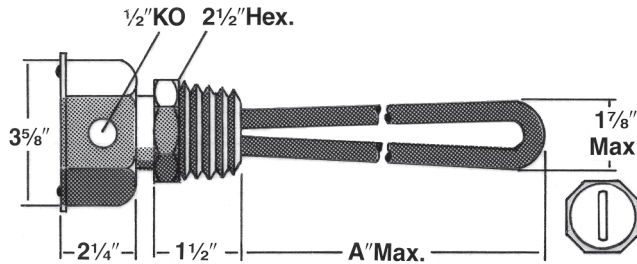

2" NPT: Copper Sheath

No. of Elements: 1			
Plug Type: Brass Screw			
Watts/sq. in.: Approx. 45			
Application: Water			
Terminal Enclosure: NEMA 1			

A Dim. Imm. Lgth	Cat. No.	Kilo-watts	Volts
12"	LC13-12-XJ	1.5	120
12"	LC13-12-XJ	1.5	240
12"	LC13-12-XJ	1.5	480
18"	LC13-18-XJ	2.0	120
18"	LC13-18-XJ	2.0	240
18"	LC13-18-XJ	2.0	480



Tubular Heaters

Screw Plug

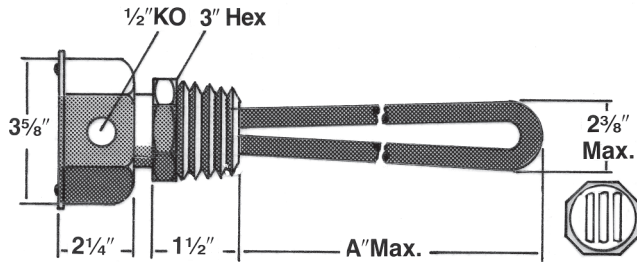

2 1/2" NPT: Copper Sheath

No. of Elements: 3

Plug Type: Brass Screw

Watts/sq. in.: Approx. 45

Application: Water

Terminal Enclosure: NEMA 1

A Dim. Imm. Lgth	Cat. No.	Kilo-watts	Volts	Phase
7 7/8"	LC15-7.37-ZJ	3.0	240	1
7 7/8"	LC15-7.37-ZJ	3.0	240	3
7 7/8"	LC15-7.37-ZJ	3.0	480	3
8 7/8"	LC15-8.87-ZJ	3.75	240	1
8 7/8"	LC15-8.87-ZJ	3.75	240	3
8 7/8"	LC15-8.87-ZJ	3.75	480	3
11 3/8"	LC15-11.37-ZJ	4.5	240	1
11 3/8"	LC15-11.37-ZJ	4.5	240	3
11 3/8"	LC15-11.37-ZJ	4.5	480	1
11 3/8"	LC15-11.37-ZJ	4.5	480	3
17 3/8"	LC15-17.37-ZJ	6.0	240	1
17 3/8"	LC15-17.37-ZJ	6.0	240	3
17 3/8"	LC15-17.37-ZJ	6.0	480	1
17 3/8"	LC15-17.37-ZJ	6.0	480	3
19 1/8"	LC15-19.12-ZJ	7.5	240	1
19 1/8"	LC15-19.12-ZJ	7.5	240	3
19 1/8"	LC15-19.12-ZJ	7.5	480	1
19 1/8"	LC15-19.12-ZJ	7.5	480	3
24 1/2"	LC15-24.5-ZJ	9.0	240	1
24 1/2"	LC15-24.5-ZJ	9.0	240	3
24 1/2"	LC15-24.5-ZJ	9.0	480	1
24 1/2"	LC15-24.5-ZJ	9.0	480	3

Steel Sheath

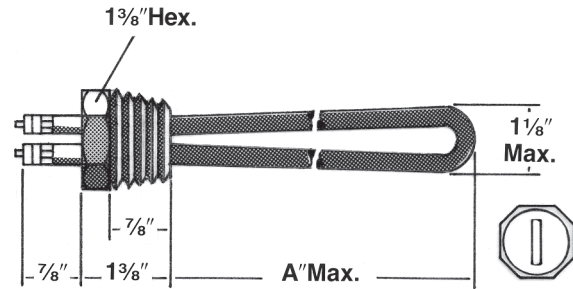

1" NPT: Steel Sheath

No. of Elements: 1

Plug Type: Steel Screw

Watts/sq. in.: Approx. 20

Application: Low Viscosity Oil

A Dim. Imm. Lgth	Cat. No.	Kilo-watts	Volts
9 1/2"	LS9-9.5-X	.37	120
9 1/2"	LS9-9.5-X	.37	240
12 1/2"	LS9-12.5-X	.50	120
12 1/2"	LS9-12.5-X	.50	240
18 7/8"	LS9-18.87-X	.80	120
18 7/8"	LS9-18.87-X	.80	240

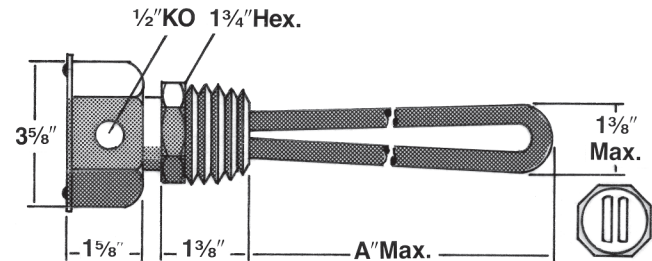

1 1/4" NPT: Steel Sheath

No. of Elements: 2

Plug Type: Steel

Watts/sq. in.: Approx. 20

Application: Low Viscosity Oil

Terminal Enclosure: NEMA 1

A Dim. Imm. Lgth	Cat. No.	Kilo-watts	Volts
12 1/2"	LS11-12.5-YJ	1.0	120
12 1/2"	LS11-12.5-YJ	1.0	240

TUBULAR



Tubular Heaters

Screw Plug

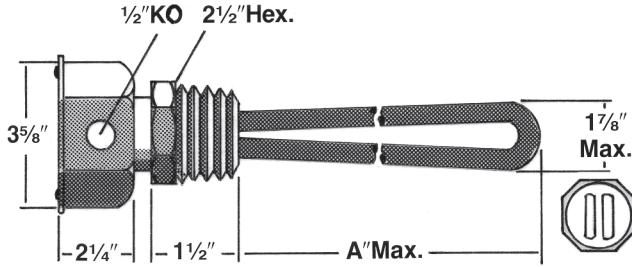

2" NPT: Steel Sheath

No. of Elements: 2

Plug Type: Steel Screw

Watts/sq. in.: Approx. 20

Application: Low Viscosity Oil

Terminal Enclosure: NEMA 1

A Dim. Imm. Lgth	Cat. No.	Kilo-watts	Volts
11 3/4"	LS13-11.75-YJ	1.5	120
11 3/4"	LS13-11.75-YJ	1.5	240
11 3/4"	LS13-11.75-YJ	1.5	480
17 3/4"	LS13-17.75-YJ	2.0	120
17 3/4"	LS13-17.75-YJ	2.0	240
17 3/4"	LS13-17.75-YJ	2.0	480
19 3/4"	LS13-19.75-YJ	2.5	120
19 3/4"	LS13-19.75-YJ	2.5	240
19 3/4"	LS13-19.75-YJ	2.5	480
24 3/4"	LS13-24.87-YJ	3.0	120
24 3/4"	LS13-24.87-YJ	3.0	240
24 3/4"	LS13-24.87-YJ	3.0	480
32 3/4"	LS13-32.75-YJ	4.0	120
32 3/4"	LS13-32.75-YJ	4.0	240
32 3/4"	LS13-32.75-YJ	4.0	480
40 3/4"	LS13-40.25-YJ	5.0	120
40 3/4"	LS13-40.25-YJ	5.0	240
40 3/4"	LS13-40.25-YJ	5.0	480
47 3/4"	LS13-47.75-YJ	6.0	240
47 3/4"	LS13-47.75-YJ	6.0	480

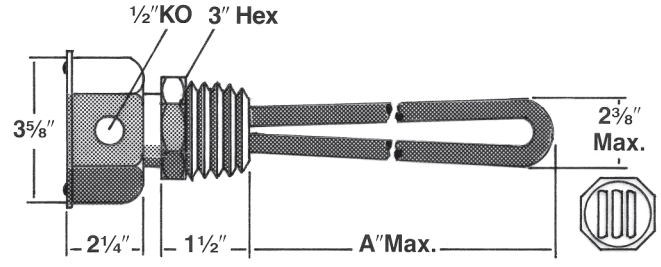

2 1/2" NPT: Steel Sheath

No. of Elements: 3

Plug Type: Steel Screw

Watts/sq. in.: Approx. 20

Application: Low Viscosity Oil

Terminal Enclosure: NEMA 1

A Dim. Imm. Lgth	Cat. No.	Kilo-watts	Volts	Phase
17 3/8"	LS15-17.37-ZJ	3.0	240	1
17 3/8"	LS15-17.37-ZJ	3.0	240	3
17 3/8"	LS15-17.37-ZJ	3.0	480	1
17 3/8"	LS15-17.37-ZJ	3.0	480	3
19"	LS15-19-ZJ	3.75	240	1
19"	LS15-19-ZJ	3.75	240	3
19"	LS15-19-ZJ	3.75	480	1
19"	LS15-19-ZJ	3.75	480	3
24 1/2"	LS15-24.50-ZJ	4.5	240	1
24 1/2"	LS15-24.50-ZJ	4.5	240	3
24 1/2"	LS15-24.50-ZJ	4.5	480	1
24 1/2"	LS15-24.50-ZJ	4.5	480	3
32 3/8"	LS15-32.37-ZJ	6.0	240	1
32 3/8"	LS15-32.37-ZJ	6.0	240	3
32 3/8"	LS15-32.37-ZJ	6.0	480	1
32 3/8"	LS15-32.37-ZJ	6.0	480	3
40"	LS15-40-ZJ	7.5	240	1
40"	LS15-40-ZJ	7.5	240	3
40"	LS15-40-ZJ	7.5	480	1
40"	LS15-40-ZJ	7.5	480	3
47 3/8"	LS15-47.37-ZJ	9.0	240	1
47 3/8"	LS15-47.37-ZJ	9.0	240	3
47 3/8"	LS15-47.37-ZJ	9.0	480	1
47 3/8"	LS15-47.37-ZJ	9.0	480	3



Tubular Heaters

Screw Plug

Incoloy Sheath

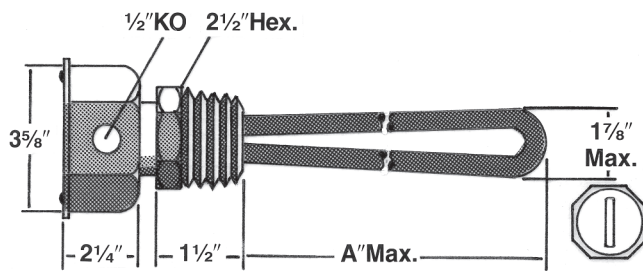

2" NPT: Incoloy Sheath

No. of Elements: 1			
Plug Type: Stainless Steel Screw			
Watts/sq. in.: Approx. 45			
Application: Process Water and Very Mild Solution			
Terminal Enclosure: NEMA 1			

A Dim.		Kilo-watts	Volts
Imm. Lgth	Cat. No.		
11 1/2"	LA13-11.5-XJ	1.5	120
11 1/2"	LA13-11.5-XJ	1.5	240
17 1/2"	LA13-17.5-XJ	2.0	120
17 1/2"	LA13-17.5-XJ	2.0	240

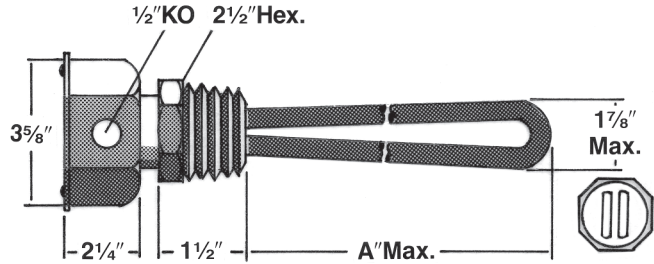

2" NPT: Incoloy Sheath

No. of Elements: 2			
Plug Type: Stainless Steel Screw			
Watts/sq. in.: Approx. 45			
Application: Process Water and Very Mild Solution			
Terminal Enclosure: NEMA 1			

A Dim.		Kilo-watts	Volts
Imm. Lgth	Cat. No.		
8"	LA13-8-YJ	2.0	240
8"	LA13-8-YJ	2.0	480
9 1/2"	LA13-9.5-YJ	2.5	240
9 1/2"	LA13-9.5-YJ	2.5	480
12"	LA13-12-YJ	3.0	240
12"	LA13-12-YJ	3.0	480
18"	LA13-18-YJ	4.0	240
18"	LA13-18-YJ	4.0	480
19 1/8"	LA13-19.12-YJ	5.0	240
19 1/8"	LA13-19.12-YJ	5.0	480
25 1/4"	LA13-25.25-YJ	6.0	240
25 1/4"	LA13-25.25-YJ	6.0	480
28 1/2"	LA13-28.12-YJ	7.0	240
28 1/2"	LA13-28.12-YJ	7.0	480
40 1/2"	LA13-40.5-YJ	10.0	240
40 1/2"	LA13-40.5-YJ	10.0	480
48"	LA13-48-YJ	12.0	240
48"	LA13-48-YJ	12.0	480
54"	LA13-54-YJ	15.0	240
54"	LA13-54-YJ	15.0	480



Tubular Heaters

Screw Plug

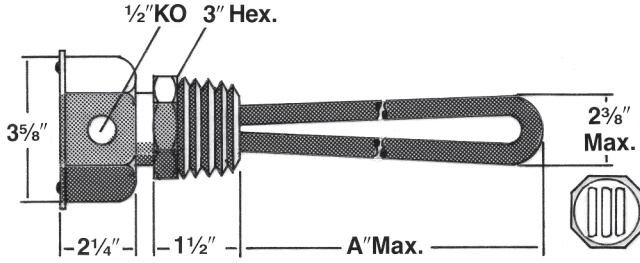

2 1/2" NPT: Incoloy Sheath

No. of Elements: 3
Plug Type: Stainless Steel Screw
Watts/sq. in.: Approx. 45
Application: Process Water and Very Mild Solution
Terminal Enclosure: NEMA 1

A Dim. Imm. Lgth	Cat. No.	Kilo-watts	Volts	Phase
7 1/8"	LA15-7.12-ZJ	3.0	240	1
7 1/8"	LA15-7.12-ZJ	3.0	240	3
7 1/8"	LA15-7.12-ZJ	3.0	480	3
11 1/4"	LA15-11.25-ZJ	4.5	240	1
11 1/4"	LA15-11.25-ZJ	4.5	240	3
11 1/4"	LA15-11.25-ZJ	4.5	480	1
11 1/4"	LA15-11.25-ZJ	4.5	480	3
17"	LA15-17-ZJ	6.0	240	1
17"	LA15-17-ZJ	6.0	240	3
17"	LA15-17-ZJ	6.0	480	1
17"	LA15-17-ZJ	6.0	480	3
19"	LA15-19-ZJ	7.5	240	1
19"	LA15-19-ZJ	7.5	240	3
19"	LA15-19-ZJ	7.5	480	1
19"	LA15-19-ZJ	7.5	480	3
24 1/8"	LA15-24.12-ZJ	9.0	240	1
24 1/8"	LA15-24.12-ZJ	9.0	240	3
24 1/8"	LA15-24.12-ZJ	9.0	480	1
24 1/8"	LA15-24.12-ZJ	9.0	480	3
32 1/8"	LA15-32.12-ZJ	12.0	240	1
32 1/8"	LA15-32.12-ZJ	12.0	240	3
32 1/8"	LA15-32.12-ZJ	12.0	480	1
32 1/8"	LA15-32.12-ZJ	12.0	480	3
39 1/2"	LA15-39.5-ZJ	15.0	240	1
39 1/2"	LA15-39.5-ZJ	15.0	240	3
39 1/2"	LA15-39.5-ZJ	15.0	480	1
39 1/2"	LA15-39.5-ZJ	15.0	480	3
47 1/8"	LA15-47.12-ZJ	18.0	240	1
47 1/8"	LA15-47.12-ZJ	18.0	240	3
47 1/8"	LA15-47.12-ZJ	18.0	480	1
47 1/8"	LA15-47.12-ZJ	18.0	480	3

Dimensions

Screw plug and enclosure dimensions shown in preceding tables may vary.

Special Features

SF-13B: Moisture tight/Explosion resistant terminal enclosure.

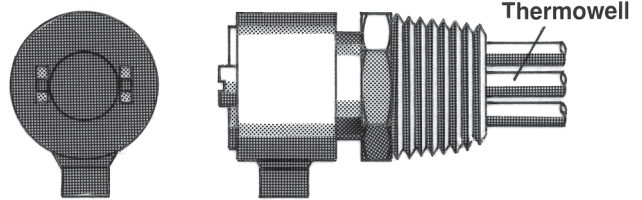

Available on:

1", 1 1/4", 2", 2 1/2", NPT screw plugs. Enclosure sizes vary with element size.

XS-55: Thermostat control. Integral bulb and capillary control with thermowell. Two temperature ranges available. Specify XS-55 (0°-100°F) or XS-55 (60°-250°F).

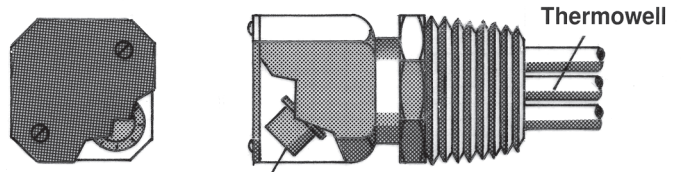

Enclosed Thermostat Control

Available on:

1 1/4", 2", 2 1/2", NPT screw plugs. Enclosure sizes vary with element size.

How To Order

Specify: catalog number, wattage, voltage, and special features, if any. Other sizes are available. Consult factory.

Example: LS13-12.5-YJ/1000W120V/SF13B/XS55 (0°-100°F)